

E-Series RF 1:4 Transmission Line Step-up Transformer 6 -1000 MHz

Rev V2

Features

- Surface mount
- 1:4 Impedance Ratio
- RoHS* Compliant
- Pb Free
- 260°C reflow compatible.
- Available on Tape and Reel

Description

M/A-COM Technology Solutions MABA-008639-TC41T7 is a RoHS compliant 1:4 RF transformer in a low cost, surface mount package. MABA-008639-TC41T7 is a wire welded RoHS version of ETC4-1T-7. Ideally suited for high volume cellular and wireless applications. Typical applications include single to balanced mode conversion and impedance matching.

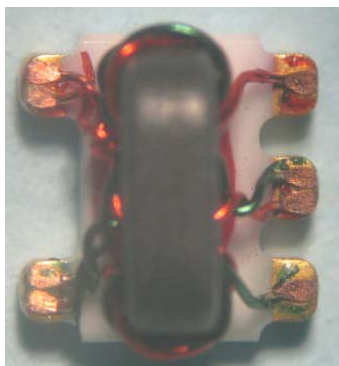

Schematic

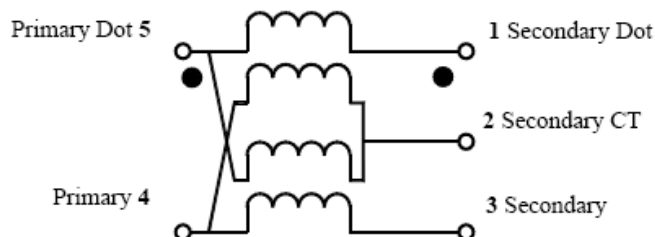

Component Dimensions

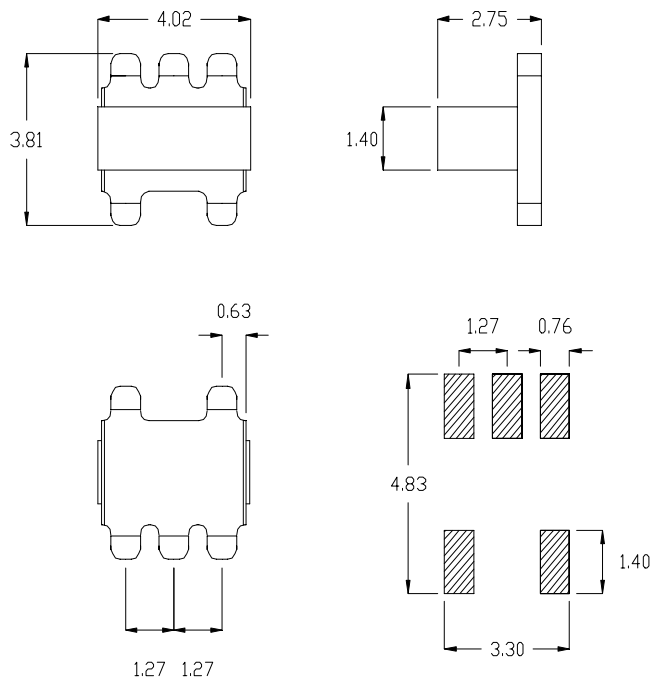

Dimensions in mm. Tolerance: .xx ± .15
Drawing not to scale

Pin Configuration

Pin No.	Function
1	Secondary Dot
2	Secondary CT
3	Secondary
4	Primary
5	Primary Dot

* Restrictions on Hazardous Substances, European Union Directive 2002/95/EC.

E-Series RF 1:4 Transmission Line Step-up Transformer 6 - 1000 MHz

Rev V2

Electrical Specifications: $T_A = 25^\circ\text{C}$, $Z_0 = 50\Omega$ ¹

Parameter	Test Conditions	Frequency	Units	Min	Typ	Max
Insertion Loss	-	6 - 600 MHz	dB	-	-	2.0
		600 - 1000 MHz	dB	-	-	3.0
Amplitude Unbalance	-	6 - 1000 MHz	dB	-	-	1.0
Phase Unbalance	-	6 - 1000 MHz	°	-	-	10

Recommended Maximum Ratings ^{1,2}

Parameter	Value
RF Power	250 mW
DC Current	30 mA
Operating Temperature	-40°C to +85°C
Storage Temperature	-55°C to +100°C

1. Exceeding any one or combination of these limits may cause permanent damage to this device.
2. M/A-COM Technology Solutions does not recommend sustained operation near these survivability limits.

Typical Performance Curves

Insertion Loss

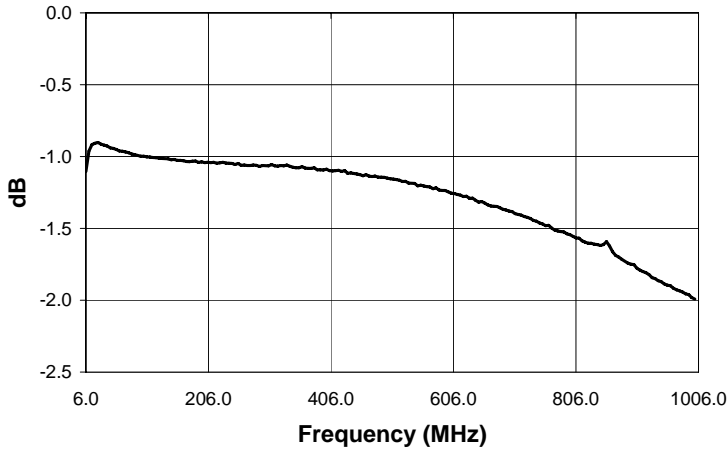

Phase Unbalance

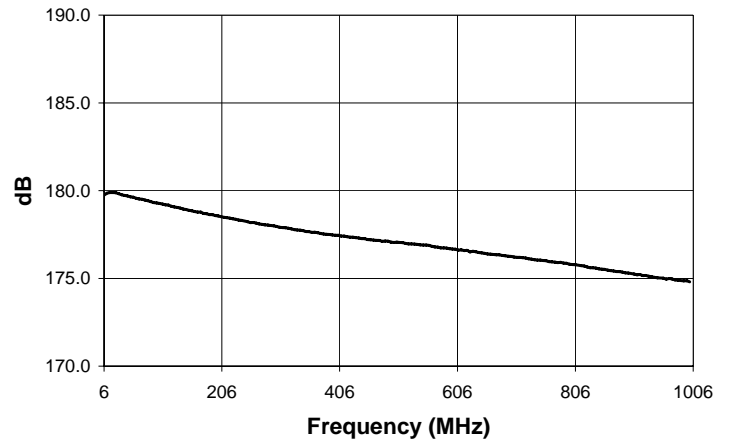

Amplitude Unbalance

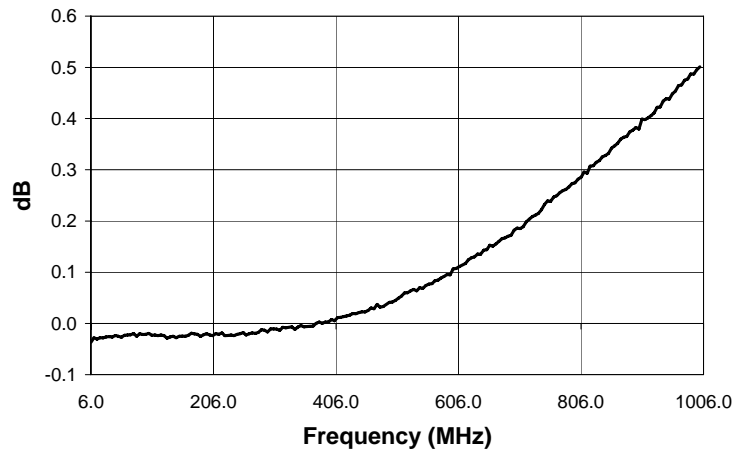

Tape & Reel Information

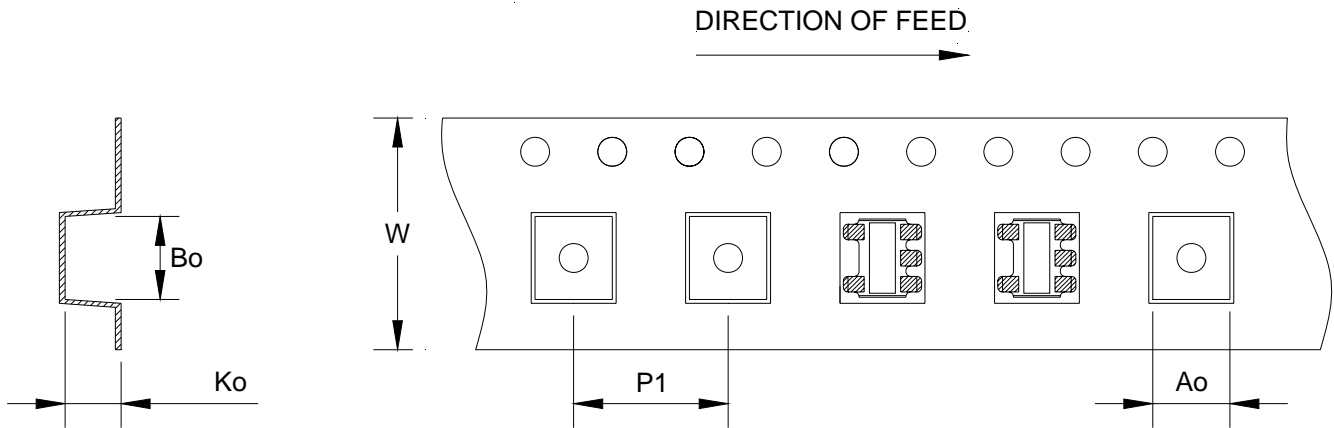

Item	Dimension
Ao	4.00mm +/-0.1mm
Bo	4.30mm +/-0.1mm
Ko	2.90mm +/-0.1mm
W	12.00mm +/-0.3mm
P1	8.00mm +/-0.1mm

Ordering Information

Part Number	Package
MABA-008639-TC41T7	2000 piece reel